



## System for Dynamic Inductive Power Transfer

### KEYWORDS

contactless, power transfer, electric vehicles, charging converter

**Nikolay D. Madzharov**

Technical University of Gabrovo,  
H.Dimitar str. 4, 5300 Gabrovo,  
Bulgaria

**Raycho T. Ilarionov**

Technical University of Gabrovo,  
H.Dimitar str. 4, 5300 Gabrovo,  
Bulgaria

**Anton T. Tonchev**

Technical University of Gabrovo,  
H.Dimitar str. 4, 5300 Gabrovo,  
Bulgaria

**ABSTRACT** Design and development of 30kW Inductive Power Transfer system for battery charging of Electric Vehicles is described in the current paper. Attention is paid to several major aspects - two different modes of power transfer (static and dynamic), high peak power transfer capability (up to 45kW@9cm), realization of battery charging via primary converter control algorithm (without secondary side charging converter) and last but not least - implementation of system (based on the current prototype) in real urban environment.

### INTRODUCTION

In the last decade almost all leading automobile companies invest for research and development in the field of electric vehicles, especially in the batteries design and their fast charging. Result of this is the first effective and economically sound solutions are already in use in city traffic. There are two main aspects associated with the electric vehicles – (1) battery capacity and mileage without charging, and (2) infrastructure and charging time.

The use of autonomous vehicle in urban environments suggests many short breaks and interruptions during travel from point A to point B, as well as many parked for a long period of time. When using electric vehicles this otherwise useless time offers a solution to one of the main problems here - battery charge. Block scheme of developed for this purpose converter is shown in Figure 1. It is based on improved full bridge scheme using five double transistor modules instead of two. One IGBT module is common to the other four, which are connected to their respective transmission coil.

The selected number of transmission coils, connected to each converter is determined by several factors, including: overall dimensions of each of them, the distance between them, the average length of the electric vehicle, and the safe distance between two subsequent vehicles on the road. Thus, low cost is achieved, and at the same time maximum efficiency of the overall solution. Of course by changing the distance between the coils and assessment of infrastructure that number can be reduced from four to two or three.

The type of used compensation is serial from the primary side (converter) and serial from the secondary side (vehicle) - SS. In this way the optimal regulation can be achieved within wide range of variation of the coefficient of magnetic coupling between the two sides of the air transformer - air gap change and horizontal misalignment. In systems for small transferred power (up to 10<sup>1</sup> kW) the use of Parallel to Parallel (PP), PPS, SPP and other types of compensation are also appropriate [4]. Impedance transformers on the primary side are used for matching between the converter and its load.

On table 1 are shown the main parameters of the developed system. The prototype converter provides both charging modes - fast dynamic (while moving) and static (parking) charging.

**Table.1. Parameters of the developed system**

Parameter	Value
Nominal Input Power	30kVA
Peak Input Power	45kVA @ 1min
Efficiency	up to 92%
Nominal Output Voltage	400V DC
Nominal Output Current	75A DC
Converter Frequency	20kHz ÷ 12kHz
Coil mass	700mm x 800mm x 90mm @ 28kg
Converter Control Technique	Frequency shift, Phase shift PWM
Gap, mm	70 ÷ 90mm
Horizontal misalignment, mm	$\Delta X = \Delta Z = \pm 100\text{mm}$

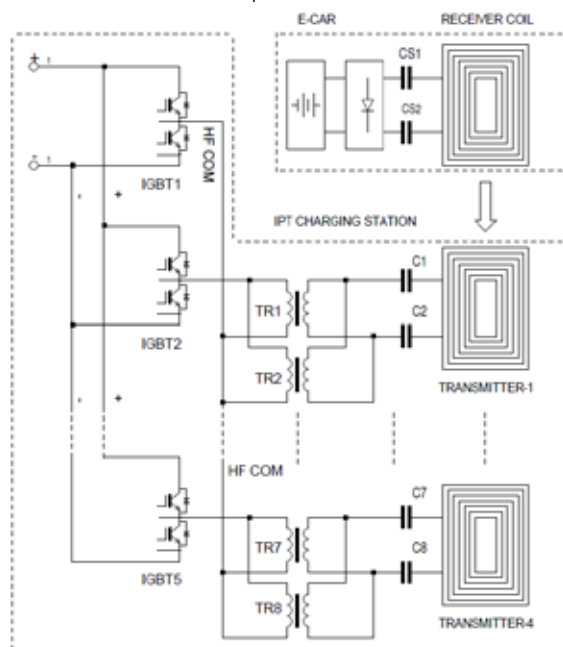

**Fig.1. Block scheme of the charging system**

The main component of the system is the “loosely coupled” transformer formed from the both coils - primary and

secondary. A 3D model of the constructed IPT coil is shown on Figure 2.

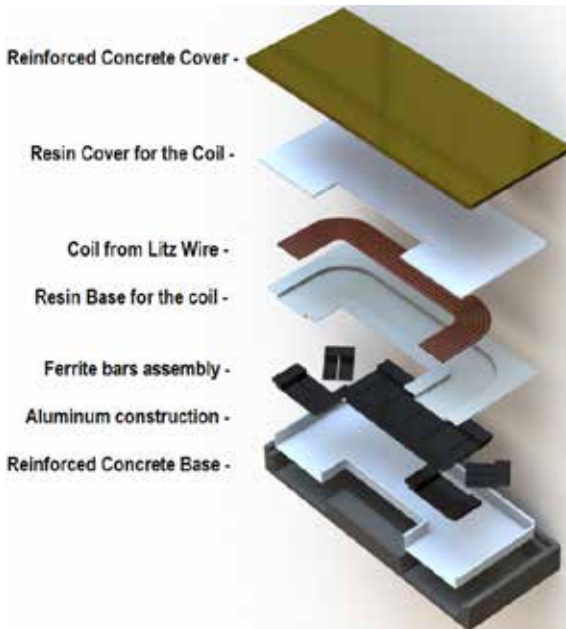

Fig.2. 3D section view of Primary IPT Coil for implementation in real urban conditions (the next stage of the project)

Specifics of the design of the coil are determined by the requirements for its implementation. In this shall be required maximum utilization of the area under the EV. At the same time it should be possible to transfer energy in the presence of horizontal and vertical misalignment of the two coils each other.

In order to improve electromagnetic compatibility additional shielding should be designed to protect the EV bottom side from radiation when coils are not aligned properly (Figure 3). This helps to protect both people and objects around the system and to meet the requirements of ICNIRP for such cases - 27µT electromagnetic induction for 3÷150kHz [2].

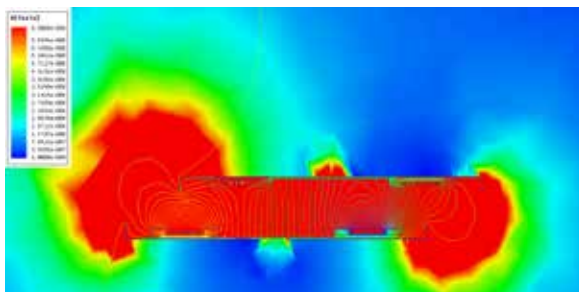

Figure 3. Electromagnetic field distribution pattern for 100mm horizontal misalignment

Instead of additional shielding around the secondary coil the dimensions of the primary could be reduced. Thus when the coils are not aligned electromagnetic field will be "reflected" earthward (right side of Fig.3).

For analyses and experiments special sensor less mechanism for switching between each one transmitting coil is developed - algorithm based on the changes of the bridge diagonal current and resonant frequency. The main aspects and terms of this principle are shown on Figure 4 [1].

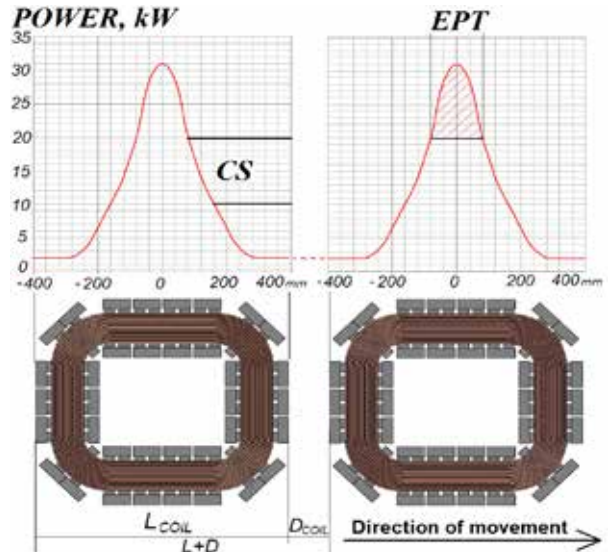

Figure 4. Coil switching block scheme

The passage of the secondary (on the EV) winding on the primary (charging station) "draws" a current changing curve analogous to that shown in Figure 5 (secondary coil is not shown). Thus, when the primary current starts to fall and reaches the CS<sub>ZONE</sub> (Coil Switching Zone) working coil is switched to next one. The power absorbed by the primary side of the system is relatively equal to the losses of the system – primary and secondary coils of the IPT system are not yet aligned with each other and there is no magnetic coupling between them. The result from applying frequency shift regulation is [3,4]:

$$V_{HF} = \frac{v \cdot d \cdot 2\sqrt{2}}{\pi} \quad (1)$$

$$I_{HF} = \frac{V_{HF} \cdot \cos \varphi}{R} \quad (2)$$

$$P = \frac{V_{HF}^2 \cdot \cos^2 \varphi}{R} \quad (3)$$

$$P = \frac{V_{HF}^2}{R} \cdot \frac{1}{1 + Q^2 \left( \frac{\omega}{\omega_0} - \frac{\omega_0}{\omega} \right)^2} \quad (4)$$

By adding algorithm for phase shift PWM in equation (4) the result is:

$$P = \frac{[V_{HF} \cdot (1-D)]^2}{R} \cdot \frac{1}{1 + Q^2 \left( \frac{\omega}{\omega_0} - \frac{\omega_0}{\omega} \right)^2} \quad (5)$$

Also an important feature here is the transit time of the secondary winding during the so-called EPT<sub>AREA</sub> – Efficient Power Transfer Area (efficiency ≥ 80%). It is proportional to the amount of energy transferred to the secondary side. Along with the on/off time constants this parameter determines the maximum speed during the "on route" charging process. EPT<sub>AREA</sub> is important in practice because it determines the optimal efficiency of the process and can be used as a point for transition between the coils [1]. Transferred energy is proportional to the vehicle speed and EPT area:

$$E_{on} = \frac{t_{on}}{EPT} \cdot \int P(x) dx \quad (6)$$

In this case for 10m charging path (approx. 10 coils) L<sub>on</sub> will be only 1.6m, which makes the system not efficient in high speed. This is one of the future directions for improving the

process of charge during movement. A number of possible steps in this direction:

- Improving the magnetic coupling factor between coils. The result will be expansion of the EPT zone and the slope of the power transfer characteristics in function of misalignment;
- Decreasing the maximum speed of the vehicle during power transfer (applicable only on crossroads and traffic congestions);
- Increasing the ratio  $L_{coil} / D_{coil}$  - the length of the coils will be much higher than the distance between them. In result the charging time and EPT area will be bigger;
- Using advanced type of primary converter regulation;

**EXPERIMENTAL RESULTS**

The main parameters of the developed IPT transformers are shown on Table 2. Clearly can be seen the influence of vertical displacement and the resulting deviation of the magnetic path length under the IPT operating point.

**Table.2. IPT Transformer parameters for misalignment**

Vertical Gap	55mm	65mm	75mm	85mm
ZCS Frequency	14,4 kHz	13,8 kHz	13,3 kHz	13,0 kHz
N2 / N1	1,63	1,63	1,625	1,63
Coupling coeff., K	0,613	0,556	0,508	0,465
M , $\mu$ H	83,65	73,7	66	59,43
L1, $\mu$ H	79	76,7	75	73,6
L2, $\mu$ H	236	229,4	225	221,9
L1+L2 ( $L_{SER}$ ), $\mu$ H	482	453,2	431	413,8
L1-L2 ( $L_{PAR}$ ), $\mu$ H	147,4	158,4	167	176,1
$L_m$ , $\mu$ H	51,48	45,35	40,62	36,57
$L_{11}$ , $\mu$ H	27,52	31,35	34,38	37,03
$L_{22}$ , $\mu$ H	152,4	155,7	159	162,5

Interesting are the results for power transfer with "worst case" scenario (Figure 5). Here the transferred power is 1/4 from the nominal value (poor efficiency) with combination of horizontal misalignment. Such situation should be avoided from the control system in order to achieve appropriate efficiency and time for charging.

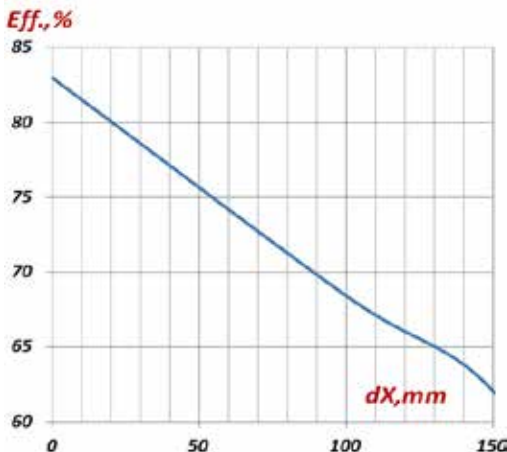

**Fig.5. IPT efficiency vs. horizontal misalignment for 7,5kW**

**power transfer rate**

The influence of the horizontal displacement between the windings on the effectiveness of transfer of energy can be seen clearly from Figure 6 and 7. To obtain the same output parameters (for  $R_L = 5\Omega$ ) the voltage across primary winding of the loosely coupled transformer is almost double (Fig.7). This leads to a significantly increased losses in compensation capacitors and reduces the efficiency of the system.

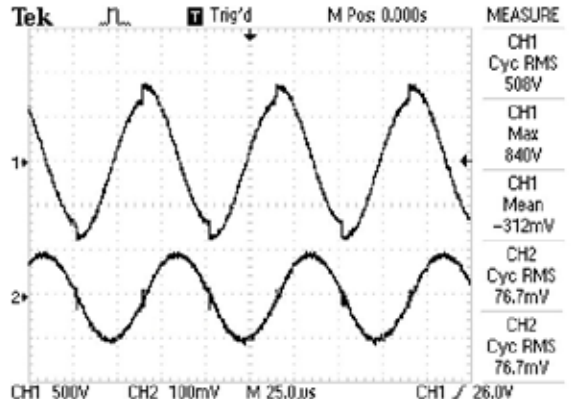

**Figure 6. Primary IPT coil voltage - horizontal displacement  $\Delta = 0$ mm, supply voltage 250V DC**

In order to reduce this influence two steps can be taken: limitation of range displacement (horizontal and vertical) or deployment of an additional mechanism for changing one or more of the reactive compensation elements (IGBT switches for compensation capacitors switching for example).

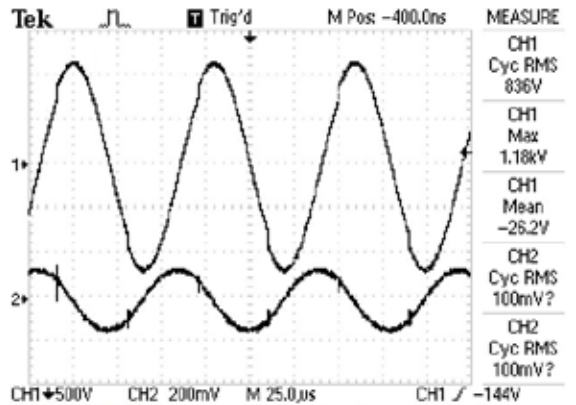

**Figure 7. Primary IPT coil voltage - horizontal displacement  $\Delta = 150$ mm, supply voltage 250V DC**

The photos of the first prototype of the IPT system are shown on Figure 6 - "4 in 1 converter" and Figure 7 - the four transmitting coils along with the secondary (pick up coil). During this demonstration successful power transfer was shown.



Figure 8. Demonstration of the complete IPT system for static and on-route charging of EV's – Converter "4 in 1"



Figure 9. Demonstration of the complete IPT system for static and on-route charging of EV's - Converter unit, Transmitting coils (4 pcs), Receiver coil with rectifier and halogen lights indication

## CONCLUSIONS

Described results in the current paper shows the progress on research and development of High power Inductive Power Transfer system for charging of Electric vehicles in urban and sub-urban environment. They are also a very good starting point for the present production process of the final IPT charger. The final model will be designed for static and "on-route" charging of EV's, operating in real urban environments. This is in line with the objectives of the project FastInCharge under FP7 program of the European Union [5]. The key points for the second stage of the project are six :

- Two separate IPT configurations for each type of charging - static and dynamic ("on route");
- Efficient dynamic ("on route") charging (up to 85% @ 30km/h);
- Efficient static charging (in special charging station) - up to 90%;
- High Power transfer rate for both modes;
- Algorithm for LiFePo battery charge, based on primary side converter control (without secondary side charging converter);
- Cost and Safety optimized charging process;

## REFERENCE

- [1] Madzharov N. D., Tonchev A. T. " IPT Station for Contactless static and dynamic charging of electric vehicles", Technical University of Gabrovo, International Scientific Conference UNITECH, Gabrovo, Bulgaria, 2013 |[2]" ICNIRP Guidelines" for limiting exposure to time varying electric, magnetic and electromagnetic fields (up to 300GHz), 1998 |[3] Kraev G., N. Hinov, L. Okoliyski, "Analysis and Design of Serial ZVS Resonant Inverter", Annual Journal of Electronics, V5, B1, TU Sofia, Faculty of Electronic Engineering and Technologies, ISSN 1313-1842, pp.169-172, 2011 |[4] Bankov, N., Al. Vuchev, G. Terziyski. Operating modes of a series-parallel resonant DC/DC converter. – Annual Journal of Electronics, Sofia, 2009, Volume 3, Number 2, ISSN 1313-1842, pp.129-132. |[5] "Innovative fast inductive charging solution for electric vehicle" - Smart infrastructures and innovative services for electric vehicles in the urban grid and road environment, part of 7th Framework Program of EU, [www.fastincharge.eu](http://www.fastincharge.eu) |